

FASTPIPE

Modular Aluminum Compressed Air Piping

3/4" - 1" - 1 1/2" - 2" (3" - 6" IN SEPARATE CATALOG)

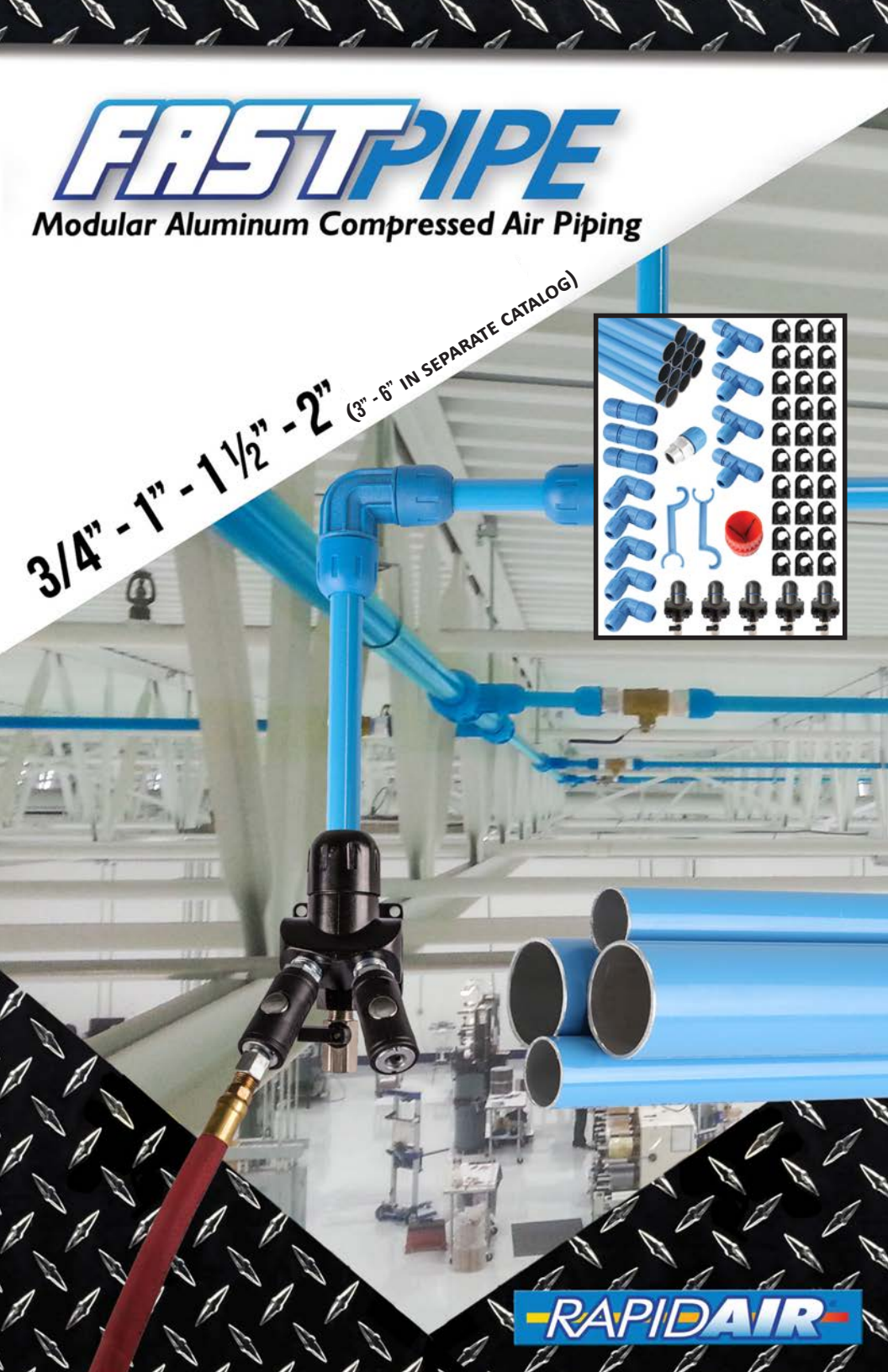

RAPIDAIR

Today's Improved Compressed Air Piping Method

FAST INSTALLATION TIME

- Compression style fittings make installation simple
- Aluminum piping is easy to cut and lift
- O-ring seals ensure a leak free system
- No gluing, threading, or soldering
- Installs in half the time as some traditional methods



DIVERSE

- Install in small shops to industrial plants
- Connect to any existing piping system
- Expand or modify the system with ease

SUPERIOR AIR QUALITY

- No corrosion in the pipe and fittings means longer tool life
- Cools hot compressed air quickly for better filter performance

ENERGY EFFICIENT

- Smooth inner wall and free flowing fittings lower compressed air costs
- Sealed connections means your compressor run time is less

3/4" - 2" Compression Type

STEP 1



STEP 2



STEP 3



(see page 10 for detailed instructions)

CHOOSE THE CORRECT SIZE OF FASTPIPE FROM THIS FLOW RATE CHART
LENGTH OF STRAIGHT RUN FROM COMPRESSOR OR 1/2 THE MAIN LOOP LENGTH

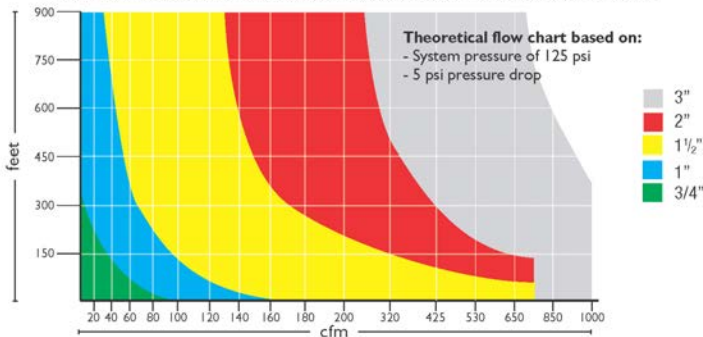



TECHNICAL SPECIFICATIONS

- 190 psi working pressure
- 0 Degrees F to 140 Degrees F
- Compatible with all types of compressor lubricants
- Compressed air, vacuum, inert gas

GENERAL SYSTEM RATINGS

- Conforms to ASME B31.1
- Fire resistant to flammability standard UL94HB
- OSHA Compliant



ALUMINUM PIPE SPECIFICATION 3/4" THRU 2"

- Alloy grade 5042
- Seamless extruded to ASTM B241
- Blue powder coat, color RAL5012 outside
- Green powder coat, color RAL6018 outside
- Non-chromate conversion coating inside



FITTINGS SPECIFICATION 3/4" THRU 2"

- Nylon 6 base with fiberglass reinforcement
- Bite ring: stainless steel
- O-ring: Nitrile

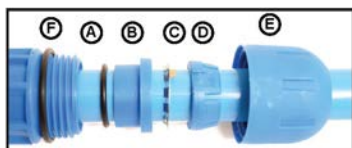

FITTINGS PARTS BREAKDOWN

- A) O-RING
- B) BACKER
- C) SS BITE RING
- D) COLLET
- E) CONE NUT
- F) TENSION O-RING*

SPARE PARTS KIT (INCLUDES A & C)

SIZE	PART NUMBER
3/4"	F1076
1"	F2076
1½"	F4076
2"	F5076

*Tension O-ring (F) is found on the 3/4" and 1" sizes only.



PIPE

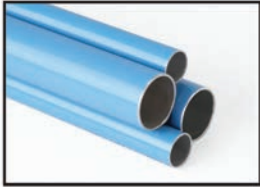

BLUE

SIZE	MM	PART #	OUTSIDE	INSIDE	LENGTH	WEIGHT
3/4"	20mm	F1000	.79 in	.69 in	19ft 8in	2.6 lbs
1"	25mm	F2000	.98 in	.87 in	19ft 8in	4.2 lbs
1 1/2"	40mm	F4000	1.57 in	1.43 in	19ft 8in	8.8 lbs
2"	50mm	F5000	1.97 in	1.81 in	19ft 8in	10.1 lbs



GREEN

SIZE	MM	PART #	OUTSIDE	INSIDE	LENGTH	WEIGHT
3/4"	20mm	F1000G	.79 in	.69 in	19ft 8in	2.6 lbs
1"	25mm	F2000G	.98 in	.87 in	19ft 8in	4.2 lbs
1 1/2"	40mm	F4000G	1.57 in	1.43 in	19ft 8in	8.8 lbs
2"	50mm	F5000G	1.97 in	1.81 in	19ft 8in	10.1 lbs

UNION



SIZE	PART NUMBER
3/4"	F1002
1"	F2002
1 1/2"	F4002
2"	F5002

REDUCING UNION



SIZE	PART NUMBER
1" x 3/4"	F2121
1 1/2" x 1"	F4221
2" x 1 1/2"	F5421

900 ELBOW



SIZE	PART NUMBER
3/4"	F1003
1"	F2003
1 1/2"	F4003
2"	F5003



90° ELBOW



SIZE	PART NUMBER
1"	F2004
1½"	F4004
2"	F5004

90° REDUCING ELBOW NPT



SIZE	DROP SIZE FEMALE	PART #
¾"	¼" NPT	F1073
¾"	½" NPT	F1093
1"	¼" NPT	F2073
1"	½" NPT	F2093
1"	¾" NPT	F2083

EQUAL TEE



SIZE	PART NUMBER
¾"	F1005
1"	F2005
1½"	F4005
2"	F5005

CROSS

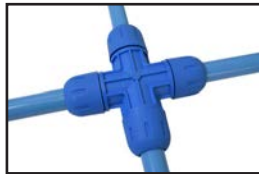

SIZE	PART NUMBER
¾"	F1051
1"	F2051
1½"	F4051
2"	F5051

REDUCING TEE



MAIN SIZE	DROP SIZE	PART NUMBER
1"	¾"	F2107
1½"	¾"	F4206
1½"	1"	F4207
2"	¾"	F5206
2"	1"	F5207

REDUCING TEE NPT



MAIN SIZE	DROP SIZE FEMALE	PART NUMBER
3/4"	1/4" NPT	F1007
3/4"	1/2" NPT	F1009
1"	1/4" NPT	F2007
1"	1/2" NPT	F2009
1"	3/4" NPT	F2008
1 1/2"	1/2" NPT	F4009
1 1/2"	3/4" NPT	F4008
2"	1/2" NPT	F5009
2"	3/4" NPT	F5008

INLINE VALVE



SIZE	PART NUMBER
3/4"	F1111
1"	F2222
1 1/2"	F4444
2"	F5555

EXPANSION JOINTS



Any piping system will expand and contract with temperature changes, use this guide for installation of expansion joints to compensate for this movement of aluminum pipe in non-conditioned buildings

Female NPT X Female NPT

SIZE	PART NUMBER
1"	F0615
1 1/2"	F0616
2"	F0617

TEMP CHANGE	MAXIMUM STRAIGHT RUN DISTANCE			
	3/4"	1"	1 1/2"	2"
10°F	700ft	600ft	550ft	500ft
20°F	500ft	460ft	420ft	370ft
35°F	350ft	310ft	280ft	250ft
55°F	260ft	230ft	200ft	190ft
70°F	200ft	190ft	170ft	150ft

THREADED MALE NIPPLE



MAIN SIZE	MALE THREAD	PART NUMBER
3/4"	1/2" NPT	F1018
3/4"	3/4" NPT	F1118
1"	1/2" NPT	F2018
1"	3/4" NPT	F2118
1"	1" NPT	F2218
1 1/2"	1" NPT	F4218
1 1/2"	1 1/2" NPT	F4418
2"	1 1/2" NPT	F5418
2"	2" NPT	F5518



WALL OUTLET



TOP INLET	OUTLET SIZE FEMALE	PART NUMBER
3/4"	(4x) 1/2" NPT	F1024
1"	(4x) 1/2" NPT	F2024

(HAS BOTTOM MOISTURE DRAIN)

WALL OUTLET WITH SHUTOFF



Each side of outlet has an extra 1/2" NPT port 2 plug included

TOP INLET	OUTLET SIZE FEMALE	PART NUMBER
3/4"	(4x) 1/2" NPT	F1024V
1"	(4x) 1/2" NPT	F2024V

(HAS BOTTOM MOISTURE DRAIN)

THRU WALL OR OUTSIDE OUTLET



TOP INLET	OUTLET SIZE FEMALE	PART NUMBER
3/4"	(1x) 1/2" NPT	F1024W
1"	(1x) 1/2" NPT	F2024W

(KIT INCLUDES A,B,C,D,E)

		DIMENSION		
		A	B	
INDUSTRIAL STYLE	30 CFM 1/4 BODY	5/16"	3/16"	type M
	70 CFM 3/8 BODY	7/16"	5/16"	type H

QUICK COUPLER



QUICK COUPLER PLUGS



30 CFM INDUSTRIAL STYLE TYPE M

PART NUMBER	MALE THREAD SIZE
K7221	1/4 NPT
K7241	1/2 NPT

PART NUMBER	FEMALE THREAD SIZE
K7220	1/4 NPT

PART NUMBER	MALE THREAD SIZE
K5221	1/4 NPT

PART NUMBER	FEMALE THREAD SIZE
K5220	1/4 NPT

70 CFM INDUSTRIAL STYLE TYPE H

PART NUMBER	MALE THREAD SIZE
K9231	3/8 NPT
K9241	1/2 NPT

PART NUMBER	FEMALE THREAD SIZE
K9230	3/8 NPT
K9240	1/2 NPT

PART NUMBER	MALE THREAD SIZE
K8221	1/4 NPT
K8231	3/8 NPT
K8241	1/2 NPT

PART NUMBER	FEMALE THREAD SIZE
K8220	1/4 NPT
K8230	3/8 NPT
K8240	1/2 NPT



SADDLE DROP



MAIN SIZE	DROP SIZE	PART NUMBER
1"	1"	F2210
1½"	¾"	F4110
1½"	1"	F4210
2"	¾"	F5110
2"	1"	F5210

SADDLE DROP



MAIN SIZE	DROP SIZE	PART NUMBER
1"	1/4" NPT	F2011
1"	1/2" NPT	F2012
1"	3/4" NPT	F2112
1½"	1/4" NPT	F4011
1½"	1/2" NPT	F4012
1½"	3/4" NPT	F4112
2"	1/4" NPT	F5011
2"	1/2" NPT	F5012
2"	3/4" NPT	F5112



MAIN SIZE	DRILL BIT	GASKET
1"	9/16" F0043	F2210C
1½"	3/4" F0044	F4210C
2"	3/4" F0044	F5210C

SADDLE DROP INSTALLATION



STEP 1



STEP 2



STEP 3



STEP 4

-System must be depressurized before installing

-To prevent chips from entering the pipe interior, stop drilling occasionally and blow out chips, grease the end of the drilling tool

- 1) Position saddle drop opposite the side of the pipe that needs the hole
Tighten securely and mark the pipe by the raised locating mark on the fitting
Mark the pipe both horizontally and vertically along the fitting edge
- 2) Drill thru one side of pipe with the drill bit, using the hole in the fitting as a locator
- 3) Insert the saddle drop gasket into the molded cavity
- 4) Position the saddle drop over the drilled hole with aligning marks, tighten securely
- 5) Attach the necessary drop pipe or threaded adapter



THREADED FEMALE NIPPLE



MAIN SIZE	FEMALE THREAD	PART NUMBER
3/4"	3/4" NPT	F1120
1"	1" NPT	F2220
1 1/2"	1 1/2" NPT	F4420



MAIN SIZE	FEMALE THREAD	PART NUMBER
3/4"	1/2" NPT	F1221
1"	1/2" NPT	F2221
1"	3/4" NPT	F2231
1 1/2"	3/4" NPT	F4231

END CAP



SIZE	PART NUMBER
3/4"	F1006
1"	F2006
1 1/2"	F4006
2"	F5006

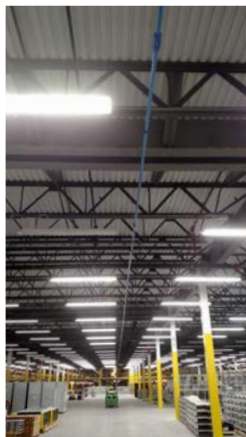



1 **CUT PIPE TO LENGTH** with tubing cutter (cut must be square) **(DO NOT USE HACK SAW)**



2 **DEBURR** the end of the pipe outside and inside **(a smooth edge allows easy fitting assembly and no damage to the fitting O-ring)**



3 **MARK END OF PIPE** for the proper insertion depth
 3/4" Fittings: 2 inches
 1" Fittings: 2-3/4 inches
 1 1/2" Fittings: 4 inches
 2" Fittings: 4-3/4 inches



4 **WET END OF PIPE** with very diluted soapy water **DO NOT USE ANY OIL OR GREASE LUBRICANT**



5 **LOOSEN FITTING CONE NUT PARTIALLY**
LOOK INSIDE EACH FITTING FOR INNER PARTS (inner parts, o-ring, stainless steel bite ring)



6 **INSERT PIPE** into fitting until pipe bottoms out **HAND TIGHTEN** fitting **FULLY TIGHTEN** fitting with FASTPIPE spanner wrenches

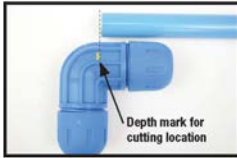

TOOL SET



MAIN SIZE	PART NUMBER
3/4"	F0136
1"	F0137
1 1/2"	F0138
2"	F0145

SPANNER WRENCH



MAIN SIZE	PART NUMBER
3/4"	F1020 each
1"	F2020 each
1 1/2"	F4020 each
2"	F5020 each

(2) Required

DEBURR TOOL



MAIN SIZE	PART NUMBER
3/4" & 1"	F0142
3/4" thru 2"	F0141

PIPE CUTTER



(3/4" thru 2")

PART NUMBER
F0140

SPRAY BOTTLE



PART NUMBER
F0139

JUMPER HOSE - RUBBER
(MALE NPT X SWIVEL FEMALE NPT)



MAIN SIZE	LENGTH	PART NUMBER
1 1/2"	18"	F0225
1 1/2"	36"	F0226
2"	36"	F0227

JUMPER HOSE - STAINLESS STEEL
(MALE NPT X SWIVEL FEMALE NPT)



MAIN SIZE	LENGTH	PART NUMBER
1/2"	2FT	F0212
1/2"	3FT	F0213
3/4"	2FT	F0214
3/4"	3FT	F0215
3/4"	5FT	F0221
1"	2FT	F0216
1"	3FT	F0217

FLAT SURFACE INSTALLATION

Use pipe clips to secure pipe to any flat surface with mounting screw

Ceiling or wall mount

Clip has 5/16" thru hole and hex bore for a 5/16" hex nut

Hex nut serves as a backer for screws

Use # 10 Drywall Screw or Tapcon

In horizontal installations, mount clip pivot tab up



PIPE CLIP

MAIN SIZE	PART NUMBER	X DIMENSION
3/4"	F1022-10 10/pk	15/16"
1"	F2022-10 10/pk	7/8"
1 1/2"	F4022-10 10/pk	1 15/16"
2"	F5022-10 10/pk	1 3/4"

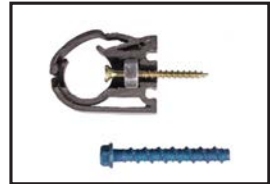

HANGING INSTALLATION



-Beam clamp-Pipe Clip
-5/16" threaded rod
-Pipe Clip



-Beam Clamp
-3/8" threaded rod
-Loop hanger



3/8 Threaded Rod x 6 FT

3/8 Hex Nut (100 Pack)

PART NUMBER
F0028

PART NUMBER
F0029

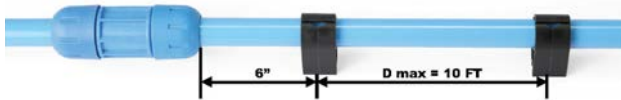

-Hangers or mounting clips should be no more than 10 ft apart and one must be at least 6" from a fitting
-Do not over tighten cantilever type tube supports, pipe must be allowed to expand and contract slightly in length
-See page 6 for expansion joint guidelines

BEAM CLAMP



-Thru hole design
-Works for both 5/16" and 3/8" threaded rod
-3/4" width opening

PART NUMBER
F0018

CANTILEVER STRUT ARM



-12" overall length
-1 5/8" standard strut

PART NUMBER
F0021

LOOP HANGER



-For 3/8" - 1 1/2" standard strut

MAIN SIZE	PART NUMBER
3/4" & 1"	F0019
1 1/2"	F0020
2"	F0024

STRUT CUSHION CLAMP



-For 1 5/8" standard strut

MAIN SIZE	PART NUMBER
3/4"	F0017
1"	F0022
1 1/2"	F0023
2"	F0025

FastPipe also comes in convenient master kit assemblies.

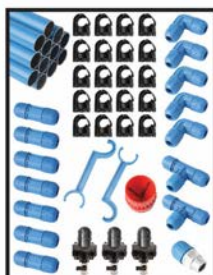
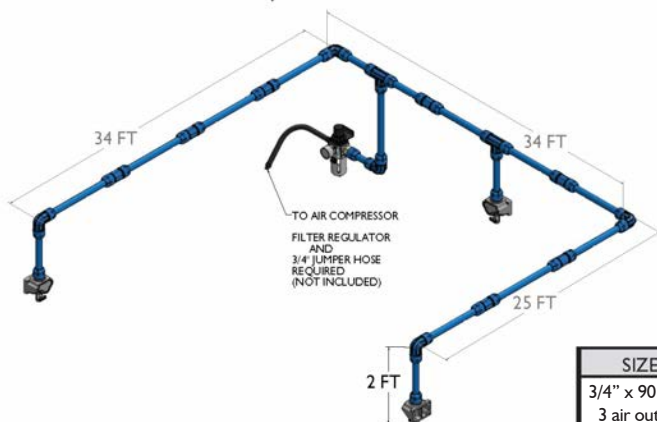

SIZE	PART NUMBER
3/4" x 90 ft kit 3 air outlets	F28070
1" x 90 ft kit 3 air outlets	F28090

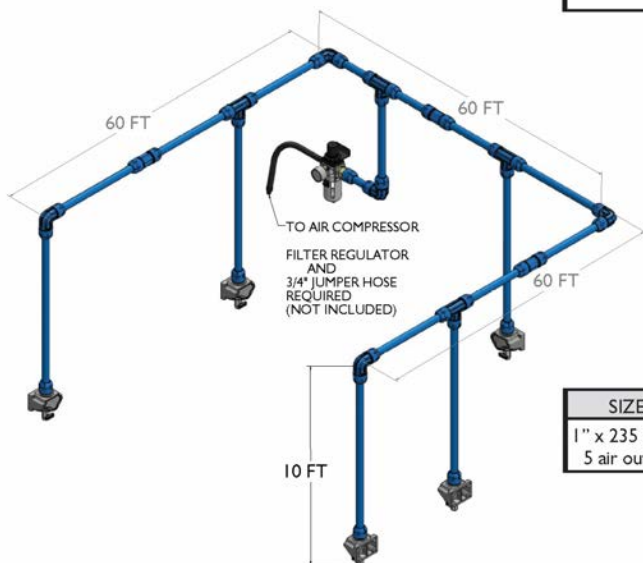

SIZE	PART NUMBER
1" x 235 ft kit 5 air outlets	F28235

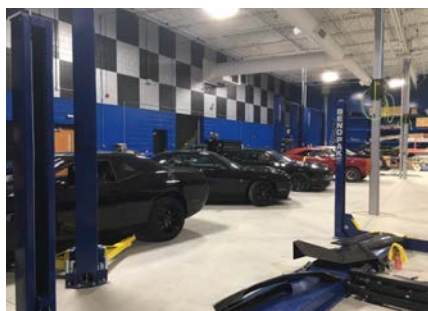

RAPIDAIR MaxLINE

Compressed Air Piping System

A great alternative for drops and long continuous runs, see our website for more details.

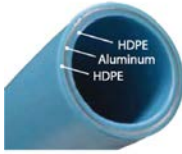

- 1/2", 3/4", 1", 2"
- Multi-Layer Semi Flexible tubing
- Inner and Outer Layer - HDPE
- Center Layer - Aluminum
- Sizes measured on inside diameter

MAXLINE FITTINGS DO NOT INTERCHANGE DIRECTLY WITH FASTPIPE, BUT CAN BE DONE THRU PIPE THREAD ADAPTER FITTINGS.



FILTER REGULATOR



PART NUMBER	PORT SIZE
K93215	3/8" NPT
K93216	1/2" NPT
K93217	3/4" NPT
K93218	1" NPT

VERTICAL FILTER REGULATOR



PART NUMBER	PORT SIZE
K96075	3/4" NPT

PUSH ON RUBBER HOSE



PART NUMBER	SIZE	LENGTH
F0238-160	3/8"	160 FT
F0238-FT	3/8"	BY THE FT
F0250-160	1/2"	160 FT
F0250-FT	1/2"	BY THE FT

FEMALE SWIVEL NPT



PART NUMBER	HOSE SIZE	THREAD SIZE
F0243	3/8"	1/4" NPT
F0244	3/8"	1/2" NPT
F0252	1/2"	1/2" NPT

MALE NPT



PART NUMBER	HOSE SIZE	LENGTH
F0240	3/8"	1/4" NPT
F0241	3/8"	3/8" NPT
F0242	3/8"	1/2" NPT
F0251	1/2"	1/2" NPT

HOSE REEL



PART NUMBER	SIZE	LENGTH
R-03050	3/8"	50 FT
R-03075	3/8"	75 FT
R-05050	1/2"	50 FT
R-05100	1/2"	100 FT

ALUMINUM MANIFOLDS



PART NUMBER	INLET SIZE	# OF PORTS	OUTLET PORT
H-50-25-4	1/2" NPT	4	1/4" NPT
H-50-25-5	1/2" NPT	5	1/4" NPT
H-50-50-4	1/2" NPT	4	1/2" NPT
H-50-50-5	1/2" NPT	5	1/2" NPT
H-75-50-3	3/4" NPT	3	1/2" NPT
H-75-50-4	3/4" NPT	4	1/2" NPT
H-75-50-5	3/4" NPT	5	1/2" NPT
H-75-75-3	3/4" NPT	3	3/4" NPT
H-75-75-4	3/4" NPT	4	3/4" NPT
H-75-75-5	3/4" NPT	5	3/4" NPT
H-100-75-3	1" NPT	3	3/4" NPT
H-100-75-4	1" NPT	4	3/4" NPT
H-100-75-5	1" NPT	5	3/4" NPT

WARNINGS

- Compressed air is **DANGEROUS** if not used properly
- Always use **EYE PROTECTION** when using compressed air
- DO NOT POINT** compressed air at your body or any person
- Pressurize system **SLOWLY**
- TURN OFF** air compressor when not in use
- CHECK** local building codes before installation
- ALWAYS RELIEVE** the system pressure when installing or performing maintenance
- Systems must have a **SAFETY RELIEF** valve installed at the compressed air source to prevent over pressurization
- When using FastPipe in direct sunlight, cover or paint the polymer fittings to protect from UV exposure** (Pipe needs no covering and can be exposed)
- Keep children away from the system



FastPipe is **NOT** designed:

- For underground burial
- To electrically ground equipment
- To be welded
- To take violent impacts
- To be used where the compressed air temperature is above 140 deg F
- For environments of caustic or corrosive chemicals

WARNING: This product can expose you to chemicals including lead, which is known to the State of California to cause cancer. For more information, go to www.P65Warnings.ca.gov.
Wash hands after handling.

CONTAINS LEAD:
MAY BE HARMFUL IF EATEN OR CHEWED.
MAY GENERATE DUST CONTAINING LEAD.
KEEP OUT OF THE REACH OF CHILDREN

FASTPIPE INSTALLATION TIPS AND RECOMMENDATIONS:

Care must be taken on any installation of the Fastpipe system. Pipes will be carrying compressed air/gas up to 190 psi. The Fastpipe system is only as safe as a thorough installation. Read all installation instructions and watch installation videos before starting. Below are some tips for a safe installation.

We strongly recommend that the installer contact our tech department for installation questions PRIOR to the installation.

- Assemble all NPT **PIPE THREADS** with two wraps of Teflon tape and then pipe sealant which prevents thread galling
- Support the pipe with clips / hangers a maximum of **10 FT SPACING** and on **ONE SIDE OF EACH FITTING**
- FASTPIPE** can be bent to conform around minor obstacles to a maximum of 15 degrees. **DO NOT OVERBEND**
- Any machine/compressor plumbed to the Fastpipe must have a **JUMPER HOSE** to reduce vibration
- Any piping system will expand and contract with temperature changes. Use **EXPANSION JOINTS** to compensate for this movement of aluminum pipe in non-conditioned buildings.
- DO NOT USE** Fastpipe for **PULSING** desiccant dryers or other like equipment.
- CAUTION** installing inert gas bulk tank systems, gas must be warmed up to Fastpipe temperature range
- Use a strain relief attached to the building for any rubber hose drops attached to the piping
- DO NOT** connect quick couplings for air hoses to reducing elbows or tee fittings. The constant connecting/disconnecting and pulling of air hoses could loosen the fitting. Use the Fastpipe **WALL OUTLET** which can be secured to a wall or post. Any hoses attached in the ceiling area to a fitting must use a strain relief attached to the building structure
- CHECK** that all fittings are tightened before pressurizing the system for the first time
- For initial installation, pressurize system **SLOWLY** to 50psi and check for leaks, then pressurize slowly to MAX 190psi
- AFTER 24 HOURS** of being pressurized, depressurize the system and **RETIGHTEN** the compression nuts. Some settling of components may have occurred. This is not optional, it must be done.
- Make sure compressor output temperature does not exceed **140°F**.

**PRODUCTS MANUFACTURED BY THE SELLER CARRY A LIMITED ONE YEAR WARRANTY.
SEE WWW.RAPIDAIRPRODUCTS.COM FOR MORE DETAILS**

LIMITED WARRANTY:

PRODUCTS MANUFACTURED BY THE SELLER CARRY A LIMITED ONE YEAR WARRANTY ONLY AS FOLLOWS:

PRODUCTS MANUFACTURED BY ENGINEERED SPECIALTIES, LLC., RAPIDAIR PRODUCTS DIVISION ARE WARRANTED TO BE FREE OF DEFECTS DUE TO FAULTY MATERIAL OR WORKSMANSHIP FOR 12 MONTHS FROM THE DATE OF PURCHASE. NORMAL WEAR AND TEAR IS NOT CONSIDERED A DEFECT IN MATERIAL OR WORKSMANSHIP. LIABILITY UNDER THIS WARRANTY IS LIMITED TO THE REPLACEMENT OF THE DEFECTIVE PART PROVIDED THAT THE FOLLOWING CONDITIONS ARE MET:

-THE COMPANY IS PROMPTLY NOTIFIED IN WRITING OF SUCH DEFECT IMMEDIATELY UPON DISCOVERY, AND THE DEFECTIVE PRODUCT IS RETURNED FOR INSPECTION

-THE DEFECT IS NOT DUE, WITHOUT LIMITATION, TO FAULTY INSTALLATION, MISALIGNMENT OF THE PRODUCT, VIBRATION, PRESSURE PULSATIONS AND/OR ORDINARY WEAR AND TEAR, CORROSION, ULTRAVIOLET DEGRADATION, OPERATION OUTSIDE THE PRODUCT SPECIFIED LIMITS AND USING THE PRODUCT FOR USES OTHER THAN ITS INTENDED USE

SELLER MAKES NO WARRANTY OF MERCHANTABILITY OF THE GOODS OR OF THE FITNESS OF THE GOODS FOR ANY PARTICULAR PURPOSE. SELLER MAKES NO WARRANTIES THROUGH ANY COURSE OF DEALING AND/OR PERFORMANCE BETWEEN THE SELLER AND BUYER. THE SELLER WILL NOT PAY CLAIMS FOR LABOR, MATERIALS AND/OR OTHER EXPENSES REQUIRED TO REPLACE OR REPAIR A DEFECTIVE PRODUCT. THE SELLER'S LIABILITY IS LIMITED TO THE REPLACEMENT OF THE DEFECTIVE PART. SELLER RESERVES THE RIGHT TO MODIFY OR ALTER THE PRODUCT AT ANY TIME.

PRODUCTS WHICH WERE NOT MANUFACTURED BY THE SELLER ARE SUBJECT TO ONLY THE ORIGINAL MANUFACTURER'S GUARANTEE AND WARRANTIES, IF ANY. SELLER DOES NOT HAVE ANY ADDITIONAL RESPONSIBILITY IF ORIGINAL MANUFACTURER DENIES WARRANTY CLAIM. IN NO EVENT, (WHETHER A PRODUCT IS WARRANTED BY SELLER OR NOT) SHALL SELLER BE LIABLE FOR ANY INCIDENTAL, CONSEQUENTIAL OR SPECIAL DAMAGES OF ANY KIND OR NATURE WHATSOEVER, INCLUDING BUT NOT LIMITED TO LOST PROFITS ARISING FROM OR IN ANY WAY CONNECTED WITH THIS AGREEMENT OR ITEMS SOLD HEREUNDER, WHETHER ALLEGED TO ARISE FROM BREACH OF CONTRACT, EXPRESS OR IMPLIED WARRANTY, OR IN TORT, INCLUDING WITHOUT LIMITATION, NEGLIGENCE, FAILURE TO WARN OR STRICT LIABILITY.



RapidAir Pipe Builder

Design your air system in minutes!



Design | Preview In 3D | Create A Parts List



**Engineered
Specialties LLC**
Auburndale, Wisconsin

1-800-954-3310 • www.rapidairproducts.com

2/2019